

johansson®

MULTISWITCHES

9 INPUTS

8 SAT. + 1 TERR.

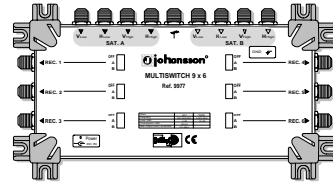
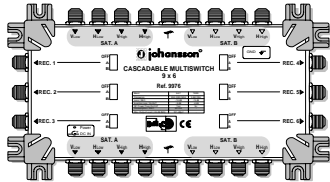

MULTI
SWITCHES

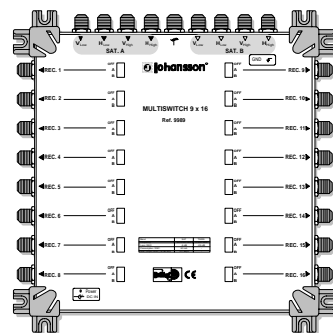
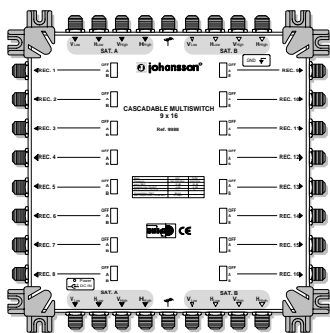

Products are subject to change without notice. 07/06

UNITRON n.v., Frankrijcklaan 27, B-8970 Poperinge, Belgium
TEL +32 57 33 33 63 FAX +32 57 33 45 24
www.johansson.be E-mail : sales@johansson.be

- Cascadable system
- Range of 4 / 6 / 8 / 12 / 16 outputs
- 9 inputs (8 SAT + 1 Terrestrial)
- DiSEqC 2.0
- Passive terrestrial signal 5-862 MHz with return path / DTT compatible
- The power supply is connected to whichever multiswitch and is used to feed the LNBs and the amplifiers Ref. 9934/9935
- The LED on each multiswitch indicates the DC power pass
- Multiswitches with different range of attenuation for equalized distribution of signals
- Selection DiSEqC A or B or disconnection of SAT signal on each receiver output
- The "stand-alone" multiswitch is made with end unit multiswitch and power supply Ref. 9933

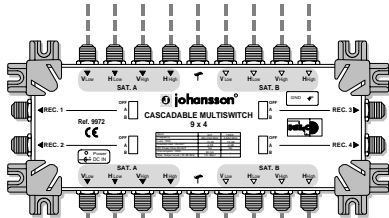

4 outputs

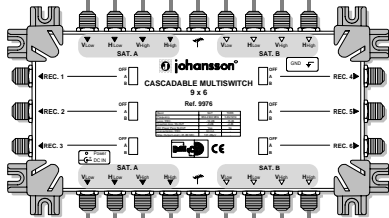
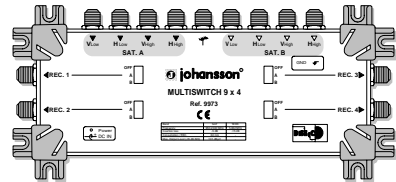

6 outputs

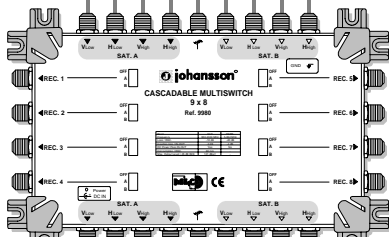
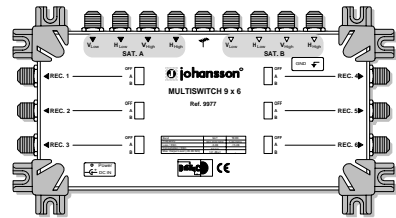

8 outputs

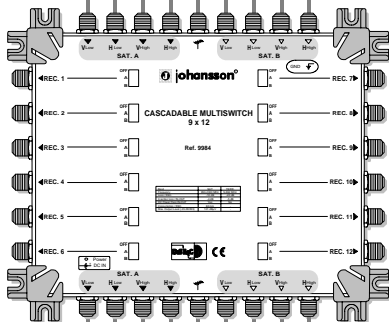
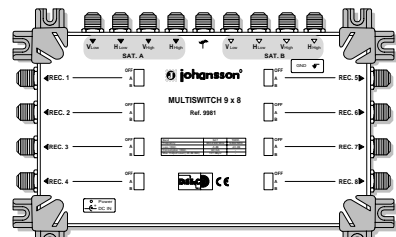

12 outputs

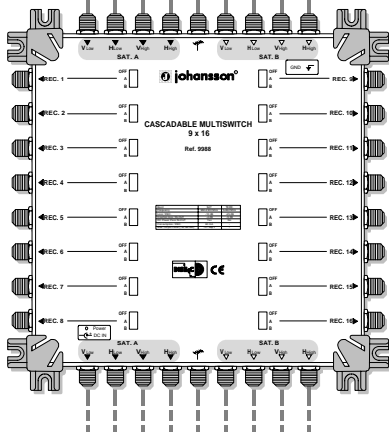
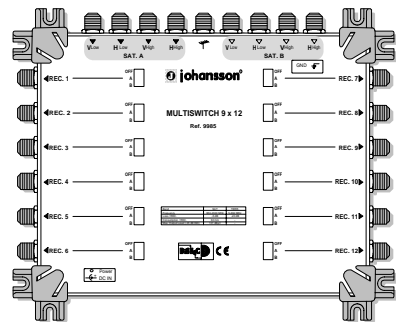

16 outputs

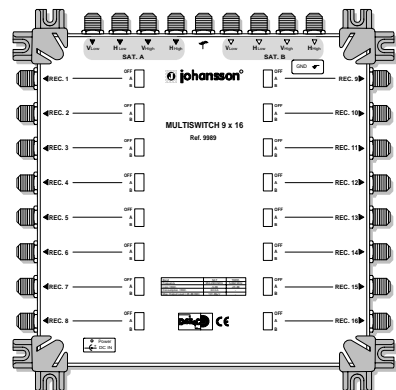

Reference / Type	Loss / Receiver	Trunk lines insertion loss	Max. output level	Consumption per receiver	DC power pass In / Out	Dimensions
------------------	-----------------	----------------------------	-------------------	--------------------------	------------------------	------------

4 outputs

9970	cascadable	Sat.: -20 dB Terr.: -25 dB	Sat.: -2 dB Terr.: -3 dB	Sat.: 101 dB μ V Terr.: -	60 mA	Sat.: yes Terr.: no	222x102x51 mm
9971	cascadable	Sat.: -15 dB Terr.: -20 dB	Sat.: -2 dB Terr.: -3 dB	Sat.: 101 dB μ V Terr.: -	60 mA	Sat.: yes Terr.: no	222x102x51 mm
9972	cascadable	Sat.: -10 dB Terr.: -15 dB	Sat.: -2 dB Terr.: -3 dB	Sat.: 101 dB μ V Terr.: -	60 mA	Sat.: yes Terr.: no	222x102x51 mm
9973	end unit	Sat.: -5 dB Terr.: -15 dB	- -	Sat.: 101 dB μ V Terr.: -	60 mA	Sat.: yes Terr.: no	222x102x51 mm
9973A	stand-alone	= end unit ref. 9973 + power supply ref. 9933					222x102x51 mm

6 outputs

9974	cascadable	Sat.: -20 dB Terr.: -25 dB	Sat.: -3 dB Terr.: -4 dB	Sat.: 101 dB μ V Terr.: -	60 mA	Sat.: yes Terr.: no	222x122x51 mm
9975	cascadable	Sat.: -15 dB Terr.: -20 dB	Sat.: -3 dB Terr.: -4 dB	Sat.: 101 dB μ V Terr.: -	60 mA	Sat.: yes Terr.: no	222x122x51 mm
9976	cascadable	Sat.: -10 dB Terr.: -15 dB	Sat.: -3 dB Terr.: -4 dB	Sat.: 101 dB μ V Terr.: -	60 mA	Sat.: yes Terr.: no	222x122x51 mm
9977	end unit	Sat.: -5 dB Terr.: -15 dB	- -	Sat.: 101 dB μ V Terr.: -	60 mA	Sat.: yes Terr.: no	222x122x51 mm
9977A	stand alone	= end unit ref. 9977 + power supply ref. 9933					222x122x51 mm

8 outputs

9978	cascadable	Sat.: -20 dB Terr.: -25 dB	Sat.: -3 dB Terr.: -4 dB	Sat.: 101 dB μ V Terr.: -	60 mA	Sat.: yes Terr.: no	222x142x51 mm
9979	cascadable	Sat.: -15 dB Terr.: -20 dB	Sat.: -3 dB Terr.: -4 dB	Sat.: 101 dB μ V Terr.: -	60 mA	Sat.: yes Terr.: no	222x142x51 mm
9980	cascadable	Sat.: -10 dB Terr.: -20 dB	Sat.: -3 dB Terr.: -4 dB	Sat.: 101 dB μ V Terr.: -	60 mA	Sat.: yes Terr.: no	222x142x51 mm
9981	end unit	Sat.: -5 dB Terr.: -20 dB	- -	Sat.: 101 dB μ V Terr.: -	60 mA	Sat.: yes Terr.: no	222x142x51 mm
9981A	stand alone	= end unit ref. 9981 + power supply ref. 9933					222x142x51 mm

12 outputs

9982	cascadable	Sat.: -20 dB Terr.: -25 dB	Sat.: -4 dB Terr.: -5 dB	Sat.: 101 dB μ V Terr.: -	60 mA	Sat.: yes Terr.: no	222x182x51 mm
9983	cascadable	Sat.: -15 dB Terr.: -20 dB	Sat.: -4 dB Terr.: -5 dB	Sat.: 101 dB μ V Terr.: -	60 mA	Sat.: yes Terr.: no	222x182x51 mm
9984	cascadable	Sat.: -10 dB Terr.: -20 dB	Sat.: -4 dB Terr.: -5 dB	Sat.: 101 dB μ V Terr.: -	60 mA	Sat.: yes Terr.: no	222x182x51 mm
9985	end unit	Sat.: -5 dB Terr.: -20 dB	- -	Sat.: 101 dB μ V Terr.: -	60 mA	Sat.: yes Terr.: no	222x182x51 mm
9985A	stand alone	= end unit ref. 9985 + power supply ref. 9933					222x182x51 mm

16 outputs

9986	cascadable	Sat.: -20 dB Terr.: -25 dB	Sat.: -4 dB Terr.: -5 dB	Sat.: 101 dB μ V Terr.: -	60 mA	Sat.: yes Terr.: no	222x222x51 mm
9987	cascadable	Sat.: -15 dB Terr.: -25 dB	Sat.: -4 dB Terr.: -5 dB	Sat.: 101 dB μ V Terr.: -	60 mA	Sat.: yes Terr.: no	222x222x51 mm
9988	cascadable	Sat.: -10 dB Terr.: -25 dB	Sat.: -4 dB Terr.: -5 dB	Sat.: 101 dB μ V Terr.: -	60 mA	Sat.: yes Terr.: no	222x222x51 mm
9989	end unit	Sat.: -5 dB Terr.: -25 dB	- -	Sat.: 101 dB μ V Terr.: -	60 mA	Sat.: yes Terr.: no	222x222x51 mm
9989A	stand alone	= end unit ref. 9989 + power supply ref. 9933					222x222x51 mm

